

# GMR VIRGO 400 / 500 TOP/CROSSE - LED

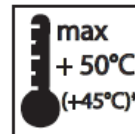

## Notice d'installation

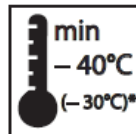

220 - 240 V  
AC



VIRGO 400



VIRGO 500

L'installation doit être réalisée par du personnel qualifié.



Pour toute question : 04 42 24 42 41  
contact@jclighting.com  
www.jclighting.com

## Dimensions

VIRGO B 400 - VB4



**Scx : 0,03m<sup>2</sup>**

**Poids maxi : 5,2 Kg**

VIRGO B 500 - VB5

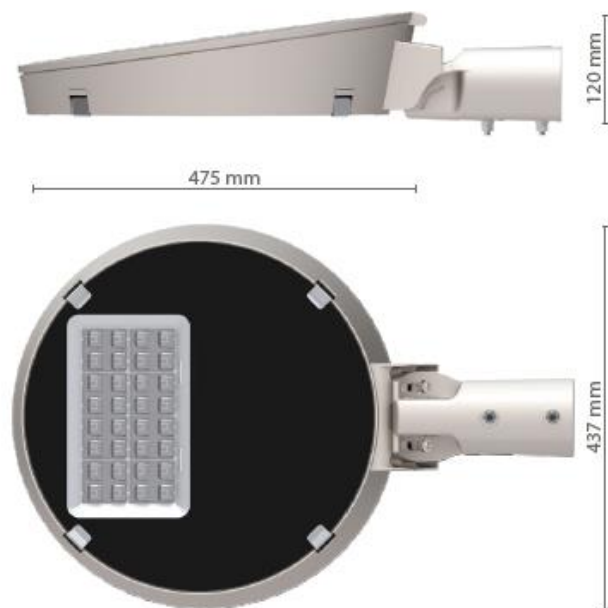

**Scx : 0,04m<sup>2</sup>**

**Poids maxi : 7,2 Kg**

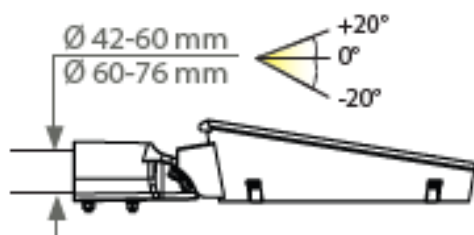

**Montage en option top 76mm  
Longueur embout 100mm**

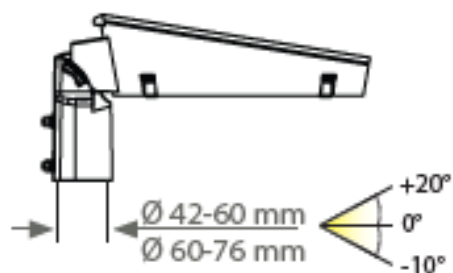

**Montage standard top 60/62mm**

## OUVERTURE AVEC OUTIL

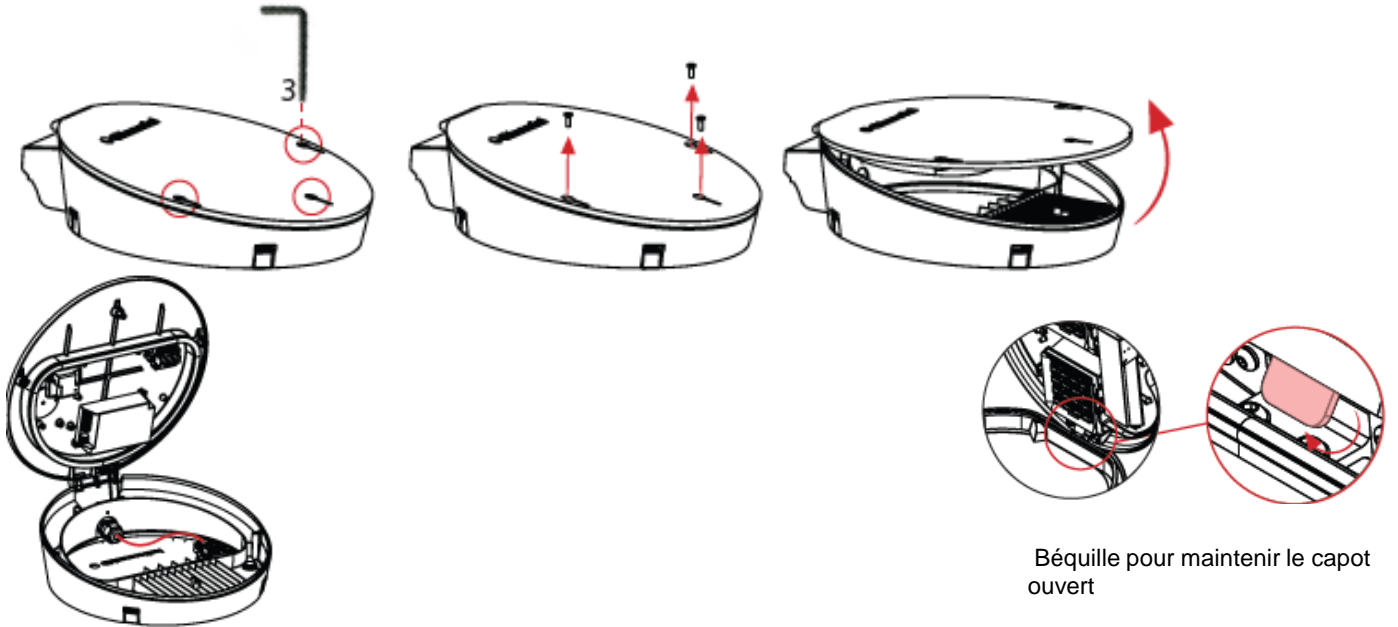

## Montage de la fixation sur le corps

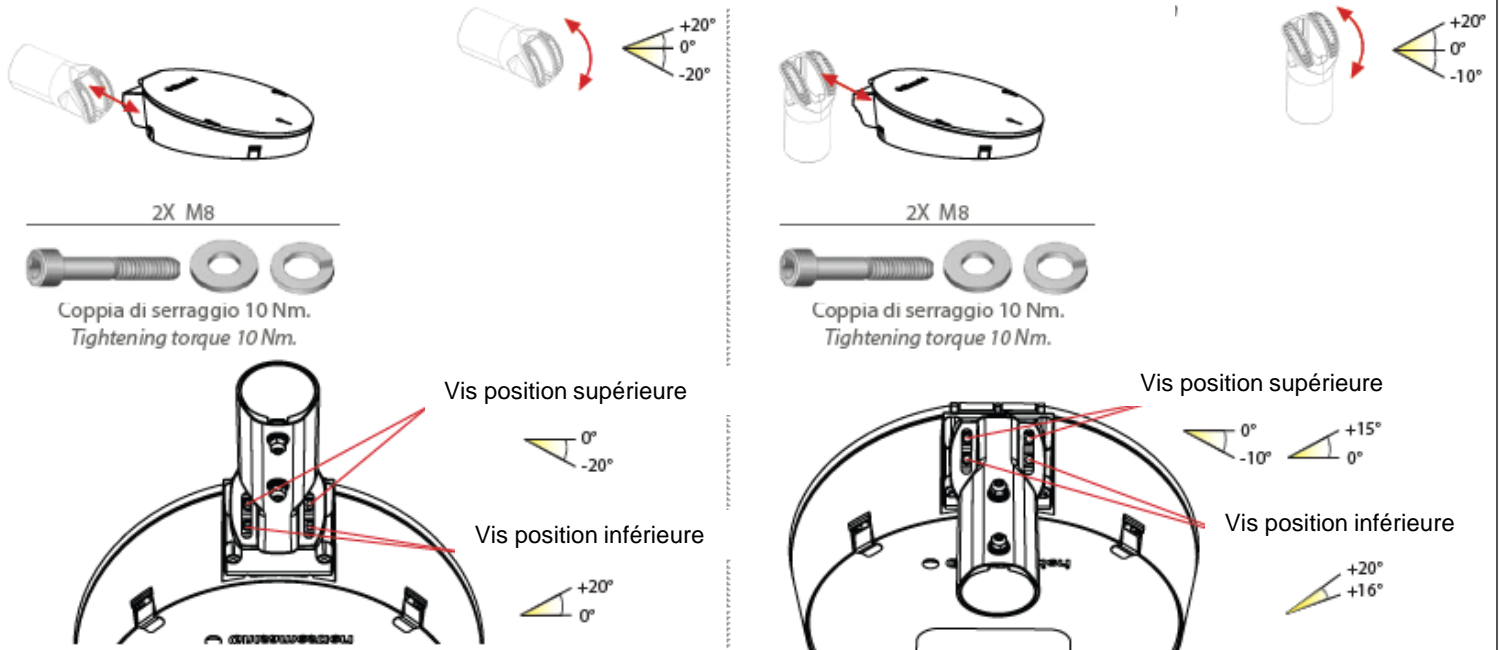

## Raccordement Classe II - Dali

Utiliser exclusivement du câble HO7 RNF

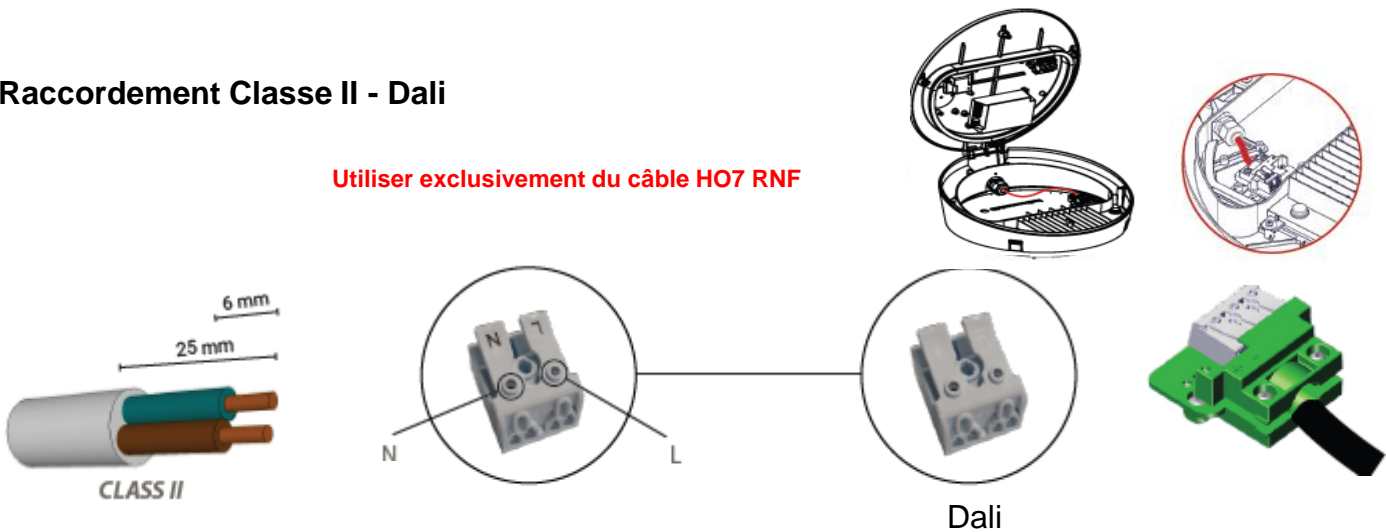

	Courant d'appel En Ampère	Temps micro-seconde	Nombre de luminaire par Type de Disjoncteur								
			Courbe B			Courbe C			Courbe D		
			10A	16A	25A	10A	16A	25A	10A	16A	25A
GL02 - 8 LED 350mA	25	236	12	20	32	20	33	52	47	81	100
GL02 - 8 LED 525mA	25	236	12	20	32	20	33	52	47	81	100
GL02 - 8 LED 1050mA	25	236	12	20	32	20	33	52	47	81	100
GL04 - 16 LED 350mA	25	236	12	20	32	20	33	52	47	81	100
GL04 - 16 LED 525mA	25	236	12	20	32	20	33	52	47	81	100
GL04 - 16 LED 1050mA	32	355	12	20	32	20	33	52	47	81	100
GL06 - 24 LED 350mA	32	355	6	10	16	10	16	26	22	37	72
GL06 - 24 LED 525mA	32	355	6	10	16	10	16	26	22	37	72
GL06 - 24 LED 1050mA	42	238	6	10	16	10	16	26	22	37	72
GL08 - 32 LED 350mA	32	355	6	10	16	10	16	26	22	37	72
GL08 - 32 LED 525mA	32	355	6	10	16	10	16	26	22	37	72
GL08 - 32 LED 1050mA	42	238	6	10	16	10	16	26	22	37	72
GL10 - 40 LED 350mA	42	238	3	5	8	5	7	13	13	22	37
GL10 - 40 LED 525mA	42	238	3	5	8	5	7	13	13	22	37
GL10 - 40 LED 1050mA	65	268	3	5	8	5	7	13	13	22	37